

- Stoperler yardımıyla profil yüksekliği ve freze dalma derinliği pratik ayarlanır.

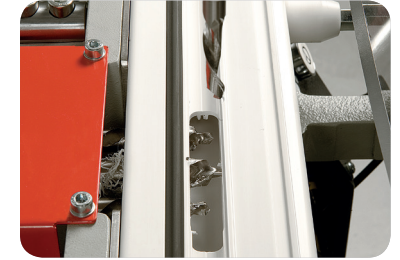

- PVC profillere su tahliye kanallarını pnömatik sistemle açar.







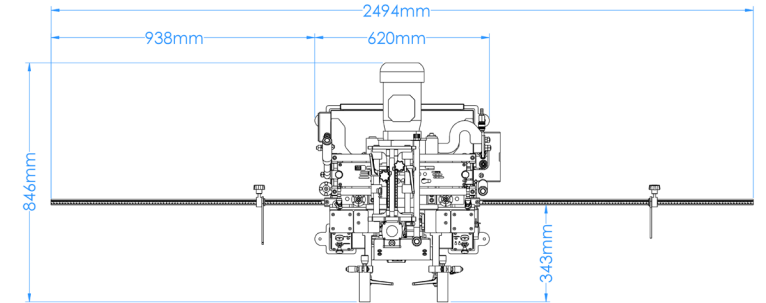

- Takip ucu kılavuzluğunda manuel kumanda edilebilme özelliğine sahiptir.



### Genel Özellikler

- PVC profillere su tahliye kanalı, ispanyolet yeri, kilit, barel yuvası ve kol yeri delikleri açar.
- Şablon ile kopya yapılabilir.
- Freze ve matkap motorları birbirinden bağımsız olarak hareket edebilir.
- Dayama parçaları sayesinde şablonsuz kanal açabilir.



 H: 1570 mm	 230 V L1-N-PE 50 / 60 Hz 0,55 kW	 130 kg	 a max: 130 mm min: 30 mm max: 90 mm	 6-8 Bar 16 l / Cycle	 D: 11 mm x 2 D: 13 mm mov.: 80 mm	 A: 60 mm	 ØD1: 3,5 mm D1: 5 mm D1: 8 mm D2: 8 mm 18000 rpm ØD2	 A: 145 mm B: 290 mm C: 70 mm D1: 8 mm D1: 5,2 mm D2: 8 mm D2: 8 mm
---	--	---	--	--	--	---	--	---