

**Bıçak Değişirme Sistemi:**

- Birden fazla seri çalışırken pratik bıçak değişimi sistemi ile çalışma kolaylığı sağlar.

**Köşe Temizleme:**

- Profilin dış kenar çapaklarını temizler.

**Orta Kayıt Alıştırma****Opsiyonlar**

- Köşe Temizleme Bıçakları.





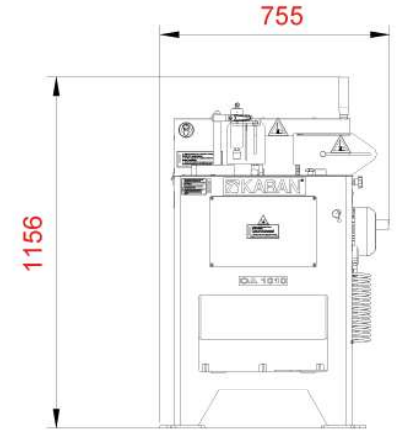
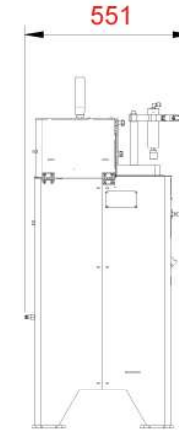



- Orta Kayıt Bıçakları

**Genel Özellikler**

- PVC profillerde 45° ve 90° de ortakayıt alıştırma işlemlerini yapar.
- PVC profillerde kaynak sonrası köşe temizleme işlemlerini yapar.
- Kolay ayarlanabilen açılabilir ve eksantrik dayamalar vardır.
- Emniyet kapakları ile güvenli çalışma sağlar.
- Bıçak yuvası yardımıyla bıçak ayarı kolayca yapılır.
- Bıçak saklama rafı ile bıçak muhafazası sağlar.

**OA 1010**

 400 V (50-60 Hz) (kW)	 6-8 bar (lt/dk)	 kg	 W x L x H (mm)	 a x h (mm) (min.)	 a x h (mm) (max.)	 ØD x Ød x b (mm)
1,5	80	102	755 x 551 x 1156	35 x 35	130 x 120	230 x 32 x 130