













**RG 2000**

 230 V (50-60 Hz) (kW) 0,03	 6-8 bar (lt/dk) 660	 kg 280	 W x L x H (mm) 1507 x 1057 x 1674	 S x K x L (mm) S: Ø3,5 - Ø4,2 K: Ø6,3 - Ø8,1 L: 15 - 40
--	---	--	---	---

**RG 3000**

 230 V (50-60 Hz) (kW) 0,03	 6-8 bar (lt/dk) 760	 kg 280	 W x L x H (mm) 1507 x 1057 x 1776	 S x K x L (mm) S: Ø3,5 - Ø4,2 K: Ø6,3 - Ø8,1 L: 15 - 40
--	---	--	---	---

### Genel Özellikler

- PVC ortakayıt profillerine ortakayıt bağlantı takozlarının otomatik vidalama işlemlerini yapar.
- Takoz vidalama süresi 11 sn'dir.
- Stoperler vasıtasıyla kolay ayarlanabilir.
- Farklı pozisyonlar için pratik ayar sistemi vardır.

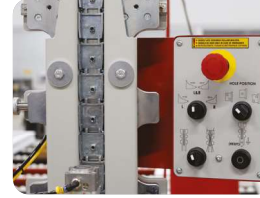

• Takoz besleme ünitesiyle zaman tasarrufu sağlar. (Bu ünite RG 3000 modelinde vardır)

• Otomatik vida besleme ünitesi ile hızlı vidalama imkanı sağlar.

**RG 2000**

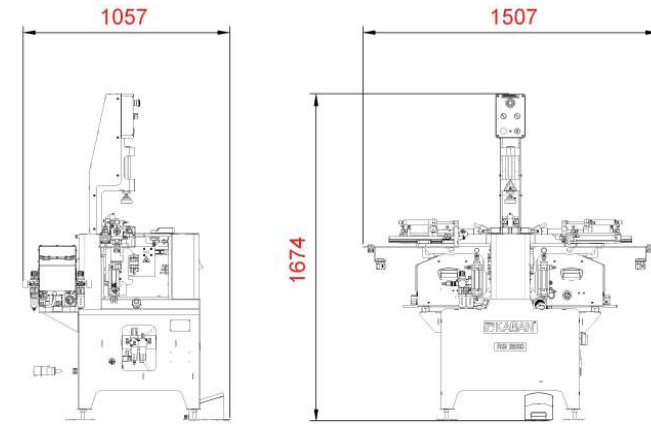

**RG 3000**

